

# 1412/4.16.139.221

---

## DESCRIPTION

- Nut Series 1412 with **internal ball return**, Flange single nut with 4-point-contact with standard synthetic wipers on both ends
- Nut shape design for assembly by flange
- Single start ball thread, ground execution according to accuracy class P1 - P5
- Miniature ball screws also available with axial play

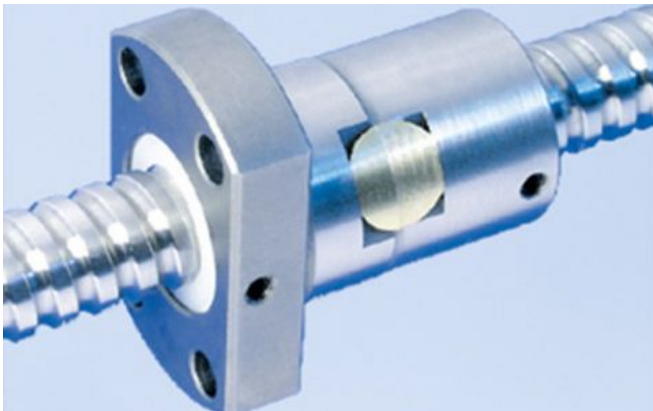

---

## TECHNICAL DATA AND DIMENSIONS

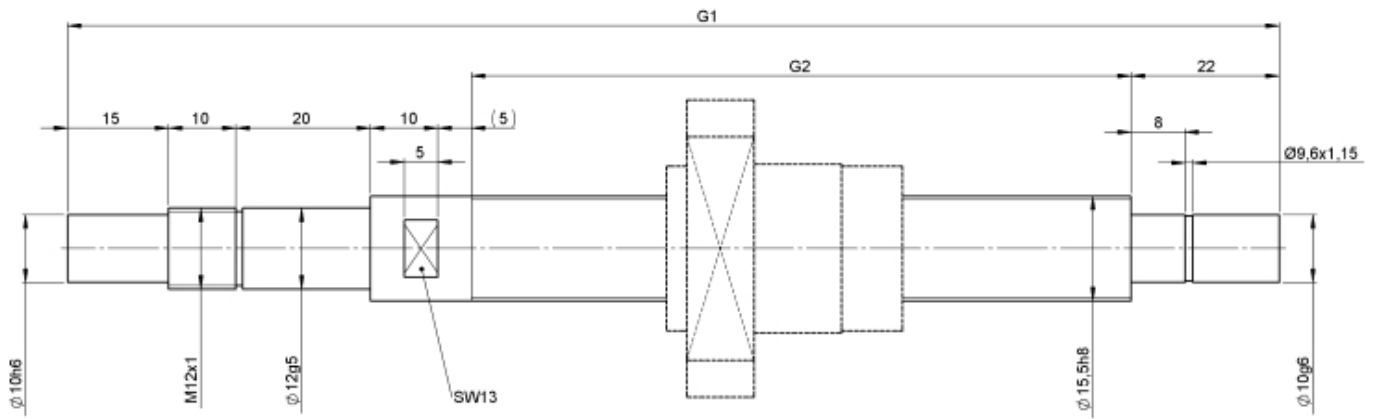
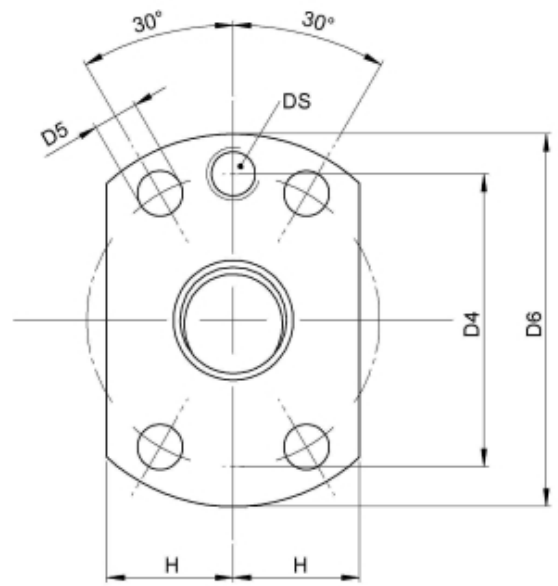
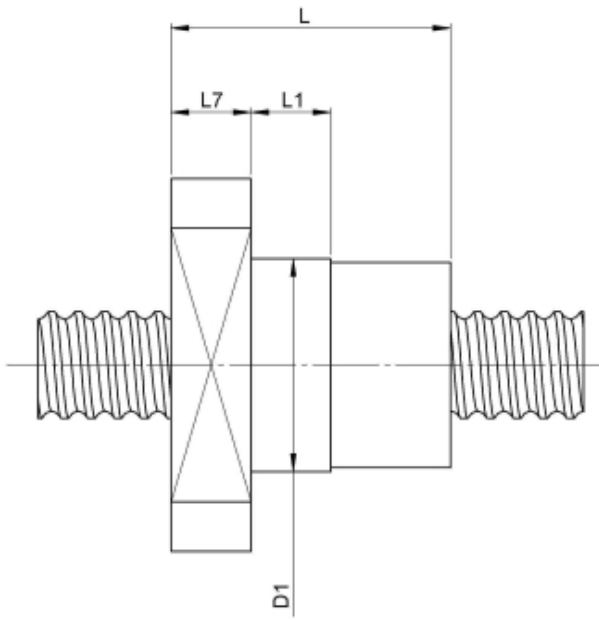

Series	1412			No. of starts	1		
Nominal diameter	[mm]	dN	16	Friction torque FROM	[Ncm]	1,4	
Lead	[mm]	P	4	Friction torque TO	[Ncm]	1,4	
Shaft style	B			Accuracy	P		
Nominal stroke	[mm]	50		Preload/backlash free/with backlash	with backlash		
Overall length	[mm]	G1	221	Nut length	[mm]	L	38
Thread length	[mm]	G2	139	Dynamic load capacity	[kN]	Ca	8,90
Ball circles	i		1x3	Static load capacity	[kN]	C0a	11,40
Ball diameter	[mm]	dW	3	Pilot diameter	[mm]	D1	28
DN-value	120000						

August Steinmeyer GmbH & Co. KG | Riedstraße 7 | 72458 Albstadt | Phone +49 (0) 7431 1288-0 | Fax +49 (0) 7431 1288-89 | [info@steinmeyer.com](mailto:info@steinmeyer.com)

Drive Technology, Ball Screws, Precision Ball Screws, Miniature Ball Screws, Ultra Thrust Ball Screws, Rotating Nuts, Cooled Ball Screws, Precision Lead Screws, Differential Rolled Screws, Rolled Ball Screws