

1412/1.3.44.85

DESCRIPTION

- Nut Series 1412 with **internal ball return**, Flange single nut with 4-point-contact with standard synthetic wipers on both ends
- Nut shape design for assembly by flange
- Single start ball thread, ground execution according to accuracy class P1 - P5
- Miniature ball screws also available with axial play



TECHNICAL DATA AND DIMENSIONS

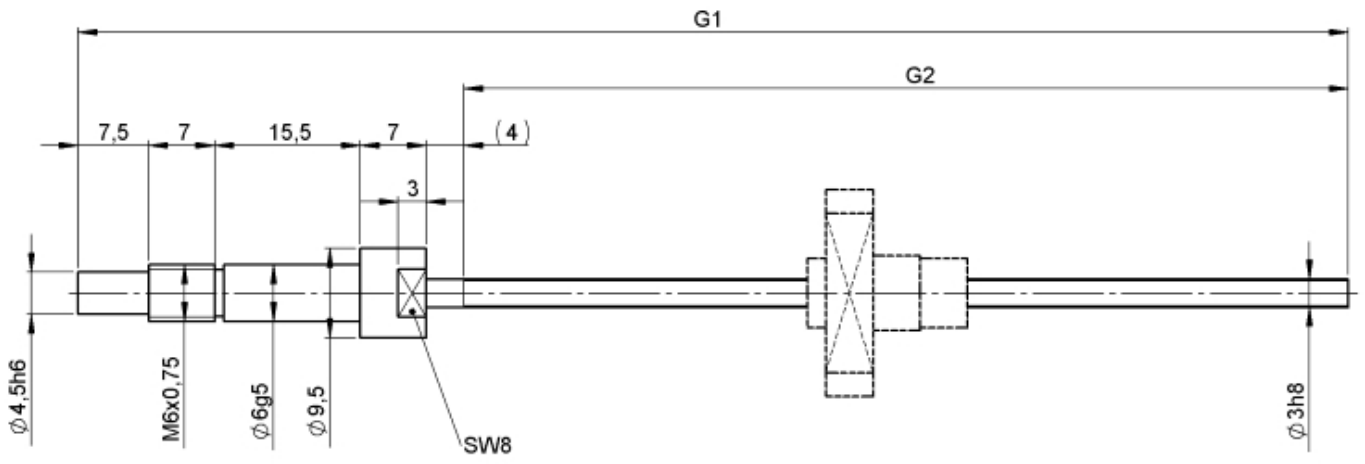
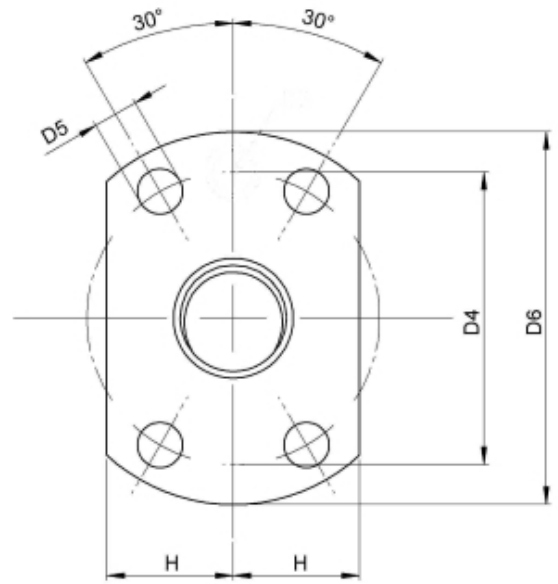
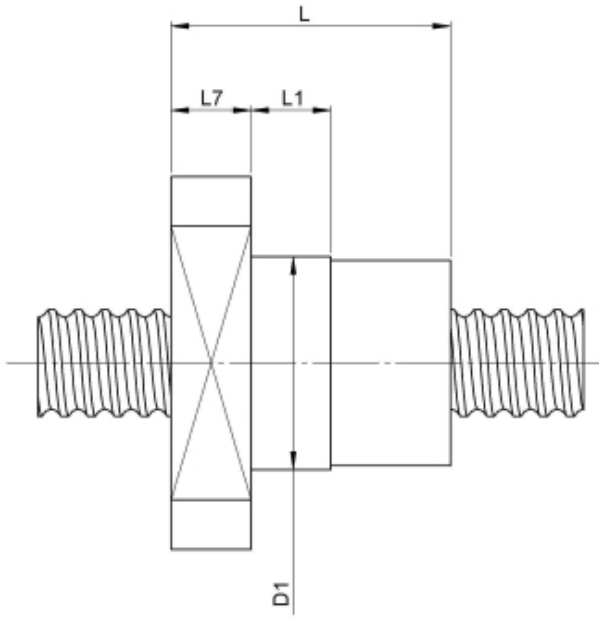

Series			1412	Accuracy			P
Nominal diameter	[mm]	dN	3	Preload/backlash free/with backlash			backlash free
Lead	[mm]	P	1	Nut length	[mm]	L	15
Shaft style			B	Flange thickness	[mm]	L7	5
Nominal stroke	[mm]		20	Dynamic load capacity	[kN]	Ca	0,24
Overall length	[mm]	G1	85	Static load capacity	[kN]	C0a	0,25
Thread length	[mm]	G2	44	Pilot diameter	[mm]	D1	8
Ball circles		i	1x2	Pilot diameter tolerance	[mm]		g6
Ball diameter	[mm]	dW	0,8	Bolt circle diameter	[mm]	D4	15
DN-value			120000	Flange hole diameter		D5	3,2
No. of starts			1	Flange diameter	[mm]	D6	22
Friction torque FROM	[Ncm]		1,0	Flange flat dimension	[mm]	H	7
Friction torque TO	[Ncm]		1,0				

August Steinmeyer GmbH & Co. KG | Riedstraße 7 | 72458 Albstadt | Phone +49 (0) 7431 1288-0 | Fax +49 (0) 7431 1288-89 | info@steinmeyer.com

Drive Technology, Ball Screws, Precision Ball Screws, Miniature Ball Screws, Ultra Thrust Ball Screws, Rotating Nuts, Cooled Ball Screws, Precision Lead Screws, Differential Rolled Screws, Rolled Ball Screws