

1510/2.12.210.280

DESCRIPTION

- Nut Series 1510 with [internal ball return](#)
- Spring preloaded double nut in housing with connecting thread and 2-point-contact, without wipers
- Nut shape design to be screwed in
- Single start ball thread, ground execution according to accuracy class P1 - P5



TECHNICAL DATA AND DIMENSIONS

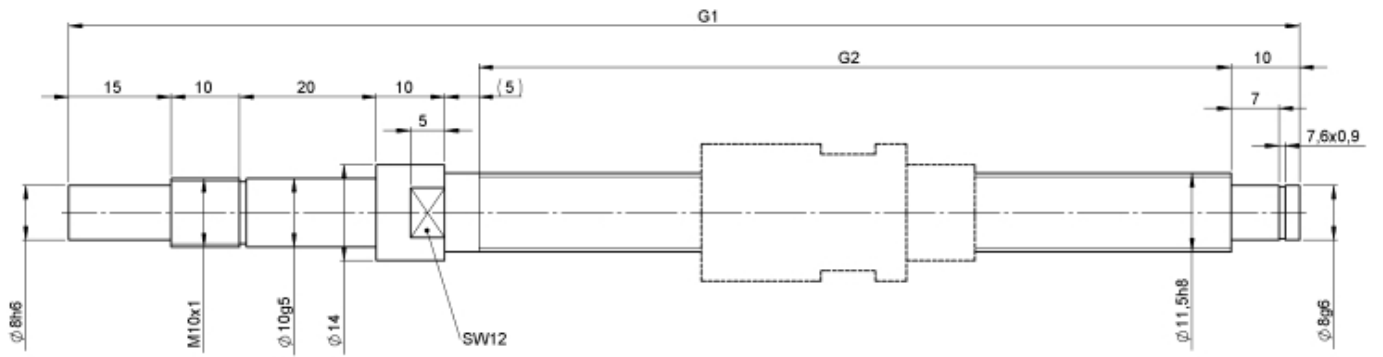
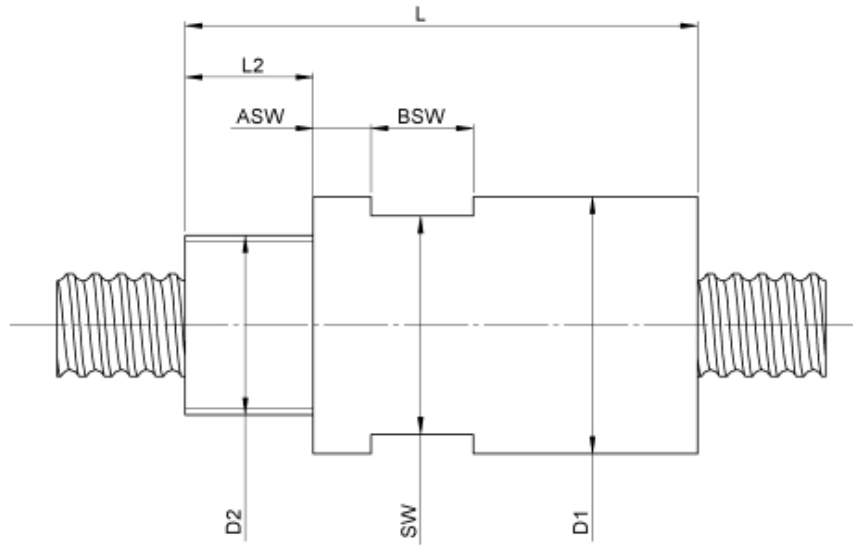

Series			1510	Max. preload	[kN]		0,08
Nominal diameter	[mm]	dN	12	Accuracy			P
Lead	[mm]	P	2	Preload/backlash free/with backlash			Preload
Shaft style			B	Nut length	[mm]	L	49
Nominal stroke	[mm]		150	Max. axial load	[kN]	Fmax	0,07
Overall length	[mm]	G1	280	Thread length	[mm]	L2	10
Thread length	[mm]	G2	210	Dynamic load capacity	[kN]	Ca	1,80
Ball circles		i	2x2	Static load capacity	[kN]	C0a	2,20
Ball diameter	[mm]	dW	1,5	Pilot diameter	[mm]	D1	24
DN-value			120000	Thread diameter	[mm]	D2	M18x1
No. of starts			1	Wrench flat	[mm]	SW	22
Friction torque FROM	[Ncm]		1,0	Width wrench flat	[mm]	BSW	10
Friction torque TO	[Ncm]		2,0	Position wrench flat	[mm]	ASW	6,5

August Steinmeyer GmbH & Co. KG | Riedstraße 7 | 72458 Albstadt | Phone +49 (0) 7431 1288-0 | Fax +49 (0) 7431 1288-89 | info@steinmeyer.com

Drive Technology, Ball Screws, Precision Ball Screws, Miniature Ball Screws, Ultra Thrust Ball Screws, Rotating Nuts, Cooled Ball Screws, Precision Lead Screws, Differential Rolled Screws, Rolled Ball Screws