

2422/10.12.510.580

DESCRIPTION

- Nut Series 2422 with [end cap ball return](#), Flange single nut with 4-point-contact, with standard synthetic wipers on both ends
- Nut shape design for assembly by flange
- Multiple start ball thread, ground execution according to accuracy class P1 - P5
- Miniature ball screws also available with axial play



TECHNICAL DATA AND DIMENSIONS

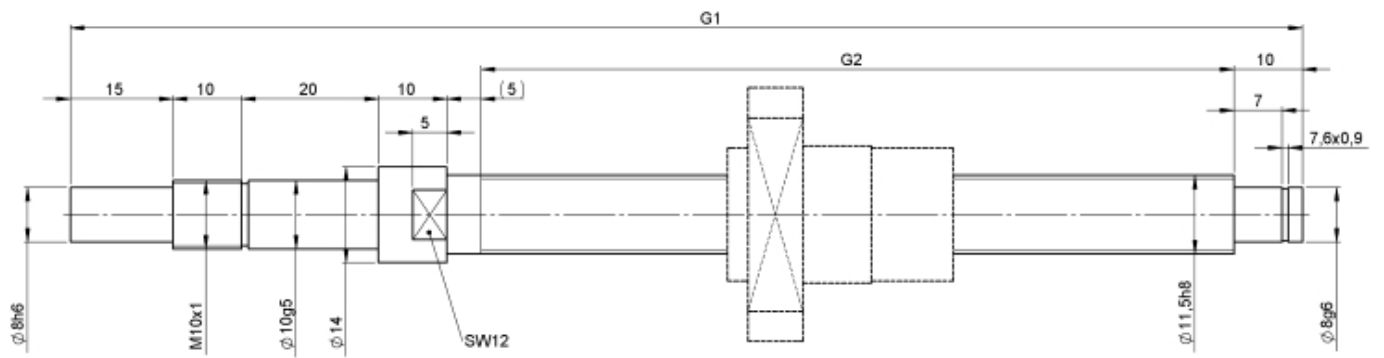
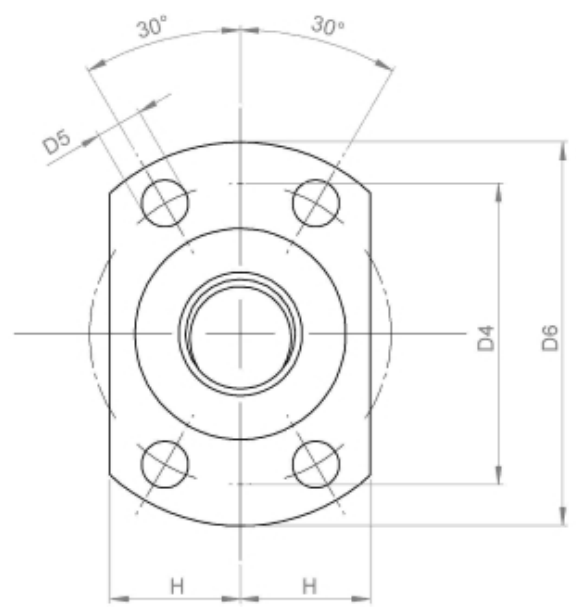
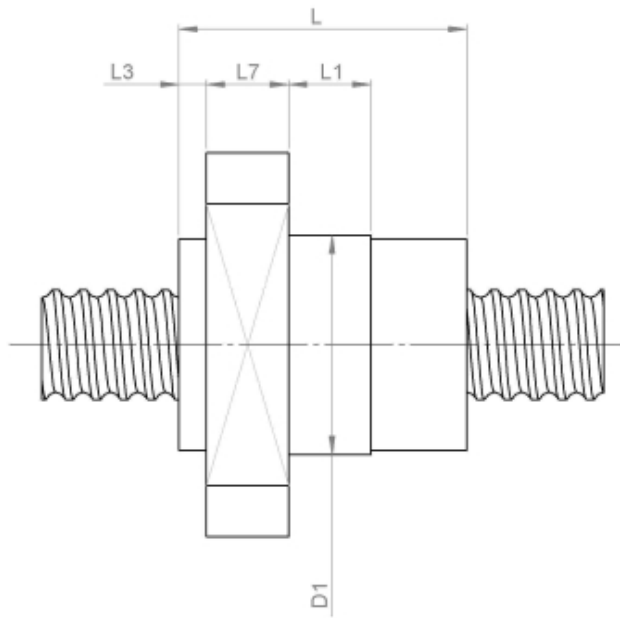

Series			2422	Pilot Length	[mm]	L1	10
Nominal diameter	[mm]	dN	12	Accuracy			P
Lead	[mm]	P	10	Preload/backlash free/with backlash			backlash free
Shaft style			B	Nut length	[mm]	L	39
Nominal stroke	[mm]		450	Wiper extension	[mm]	L3	9
Overall length	[mm]	G1	580	Flange thickness	[mm]	L7	8
Thread length	[mm]	G2	510	Dynamic load capacity	[kN]	Ca	8,50
Ball circles		i	3+3	Static load capacity	[kN]	C0a	11,00
Ball diameter	[mm]	dW	2,5	Pilot diameter	[mm]	D1	24
DN-value			160000	Pilot diameter tolerance	[mm]		g6
No. of starts			2	Bolt circle diameter	[mm]	D4	32
Friction torque FROM	[Ncm]		3,0	Flange diameter	[mm]	D6	40
Friction torque TO	[Ncm]		3,0	Flange flat dimension	[mm]	H	13

August Steinmeyer GmbH & Co. KG | Riedstraße 7 | 72458 Albstadt | Phone +49 (0) 7431 1288-0 | Fax +49 (0) 7431 1288-89 | info@steinmeyer.com

Drive Technology, Ball Screws, Precision Ball Screws, Miniature Ball Screws, Ultra Thrust Ball Screws, Rotating Nuts, Cooled Ball Screws, Precision Lead Screws, Differential Rolled Screws, Rolled Ball Screws