

1416/15.100.11.3

DESCRIPTION

- Nut Series 1416 with **internal ball return**, Flange single nut with 4-point-contact with standard synthetic wipers on both ends
- Nut shape according to DIN for assembly by flange
- Single start ball thread, ground execution according to accuracy class P1 - P5



TECHNICAL DATA AND DIMENSIONS

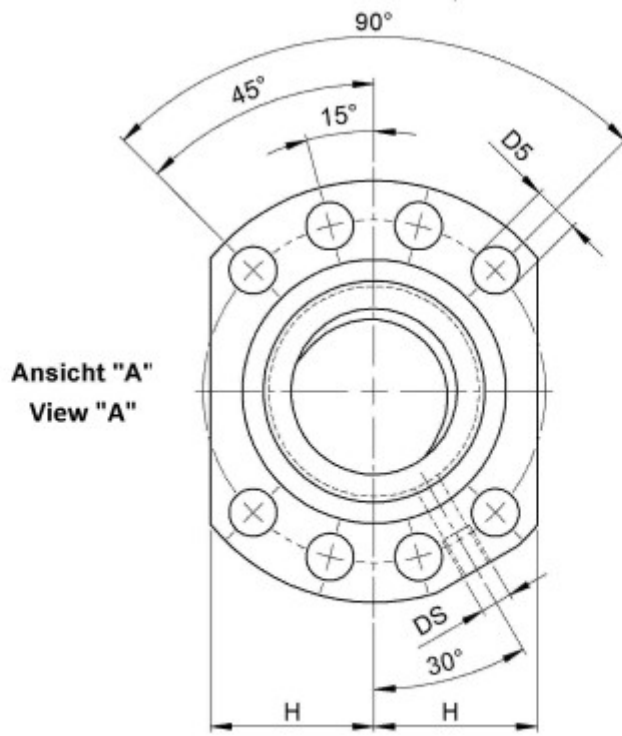
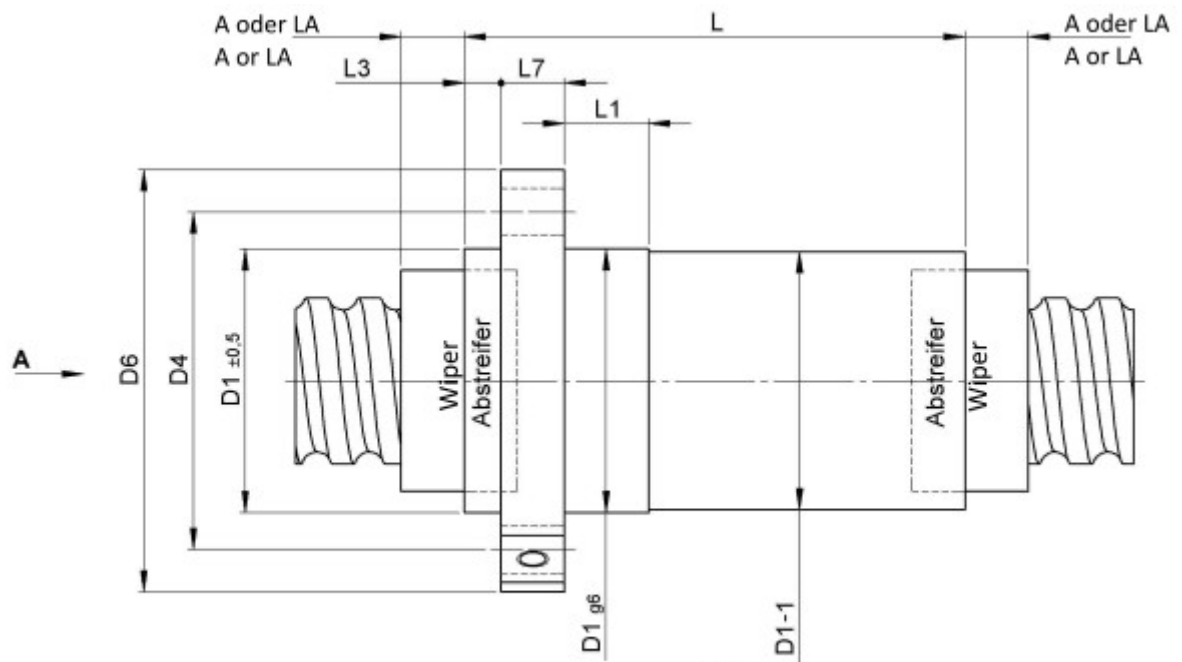

Ansicht "A"
View "A"

Form B
Shape B

Series			1416	Flange thickness	[mm]	L7	30
Nominal diameter	[mm]	dN	100	Dynamic load capacity	[kN]	Ca	152,50
Lead	[mm]	P	15	Static load capacity	[kN]	C0a	373,20
Ball circles		i	1x3	Ball diameter	[mm]	dW	11
Additional wiper extensions for combination wipers	[mm]	LA	12	DN-value			120000
Pilot Length	[mm]	L1	25	No. of starts			1
Pilot diameter	[mm]	D1	150	Stiffness	[N/μm]	Rnu,ar	1180
Pilot diameter tolerance	[mm]		g6	Friction torque FROM	[Ncm]		366,0
Bolt circle diameter	[mm]	D4	176	Friction torque TO	[Ncm]		610,0
Flange hole diameter		D5	17,5	Max. preload	[kN]		12,2
Lube hole	[mm]	DS	M8x1	Accuracy			P
Flange diameter	[mm]	D6	202	Nut length	[mm]	L	127
Flange flat dimension	[mm]	H	77,5	Wiper extension	[mm]	L3	7

August Steinmeyer GmbH & Co. KG | Riedstraße 7 | 72458 Albstadt | Phone +49 (0) 7431 1288-0 | Fax +49 (0) 7431 1288-89 | info@steinmeyer.com

Drive Technology, Ball Screws, Precision Ball Screws, Miniature Ball Screws, Ultra Thrust Ball Screws, Rotating Nuts, Cooled Ball Screws, Precision Lead Screws, Differential Rolled Screws, Rolled Ball Screws